

OWNER'S MANUAL



LumiSource®



Congratulations!

You are now the proud owner of a BOOMCHAIR™ MIG. Prepare to experience your entertainment on a whole new level. BOOMCHAIR™ MIG allows you to *HEAR* the sound and *FEEEL* the excitement. You'll experience every crash, bang, and boom while enjoying your favorite game, music, or movie. BOOMCHAIR MIG™ is also a great game seat built to endure the rigors of today's gaming environment. Take a moment to review your owner's manual before connecting your BOOMCHAIR™ MIG. Assembly and operation of the BOOMCHAIR™ MIG is simple.

If you need further assistance visit us at www.BoomChair.com or www.LumiSource.com

BOOMCHAIR™ MIG is designed and manufactured by:
LumiSource, Inc.
2950 Old Higgins Road, Elk Grove Village, IL 60007

PATENTS PENDING

READ BEFORE USE

- DO NOT wash or soak with water. If BOOMCHAIR™ MIG gets wet, disconnect power immediately and do not use until completely dry.
- Switch power off (0) and unplug BOOMCHAIR™ MIG when not in use.
- Children under 5 years old should not use this product without parental supervision.
- For INDOOR use only/ DO NOT expose to direct sunlight, moisture, or extreme temperatures.
- DO NOT use on slippery or uneven flooring.
- Excessive exposure to audio equipment at high volume may lead to hearing loss.
- DO NOT open the BOOMCHAIR™ MIG (see warning below).



Internal

- DO NOT OPEN

Caution: To reduce the risk of electric shock and fire, do not open the BOOMCHAIR™ MIG. There are no user serviceable parts inside. Refer to your warranty for service information

FCC CERTIFICATIONS

This device complies with Part 15 of the FCC rules.

Operation is subject to the following two conditions:

- (1) This device may not cause harmful interference.
- (2) This device must accept any interference received, including interference that may cause undesired operation.

Power rating: 12 Volts at 1830/mA

SET-UP GUIDE

The BOOMCHAIR™ MIG comes with the following:

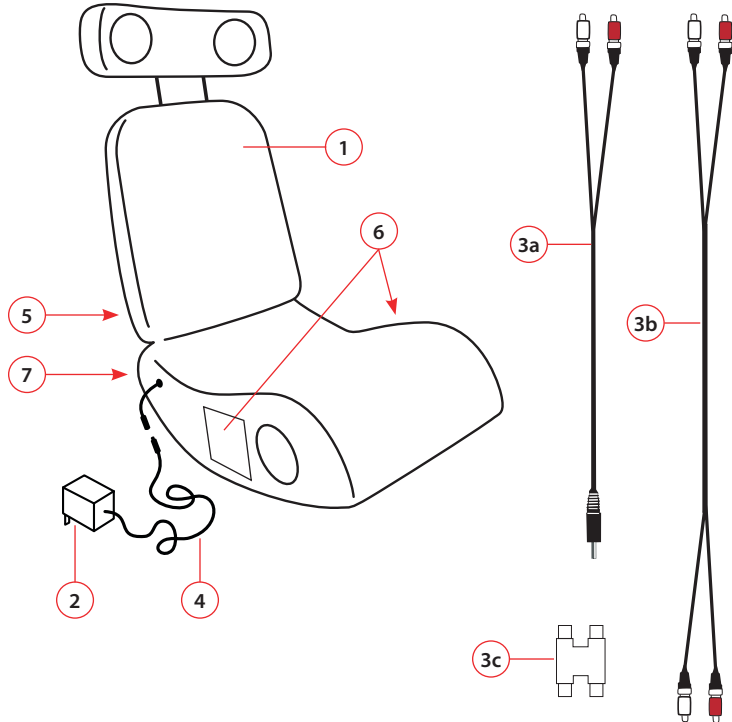

PARTS LIST:

- 1) BOOMCHAIR™ MIG
- 2) AC/DC POWER SUPPLY
- 3a) RCA CORD
(headphone jack to audio left & right channel connectors)
- 3b) RCA CORD
(audio left & right channel connectors)
- 3c) RCA AUDIO COUPLER
- 4) RECEPTACLE
- 5) HOOK & LOOP FASTENER
- 6) MESH POCKETS (2)
- 7) ADJUSTABLE RECLINE STOPPERS

SYSTEM SPECIFICATIONS

BOOMCHAIR™ MIG MULTIMEDIA FURNITURE

Dimensions: 27" L x 19" W x 37" H

Weight: 41 lbs.

2 - 3" coaxial mid-high speakers @ 5W 4 Ohms

1 - 4" sub-woofer @ 15W 4 Ohms

2 - Vibration pads

1 - 12v AC/DC UL listed power adapter

DASHBOARD CONTROL PANEL

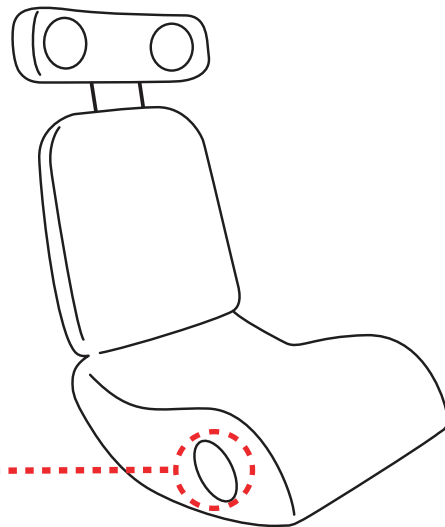
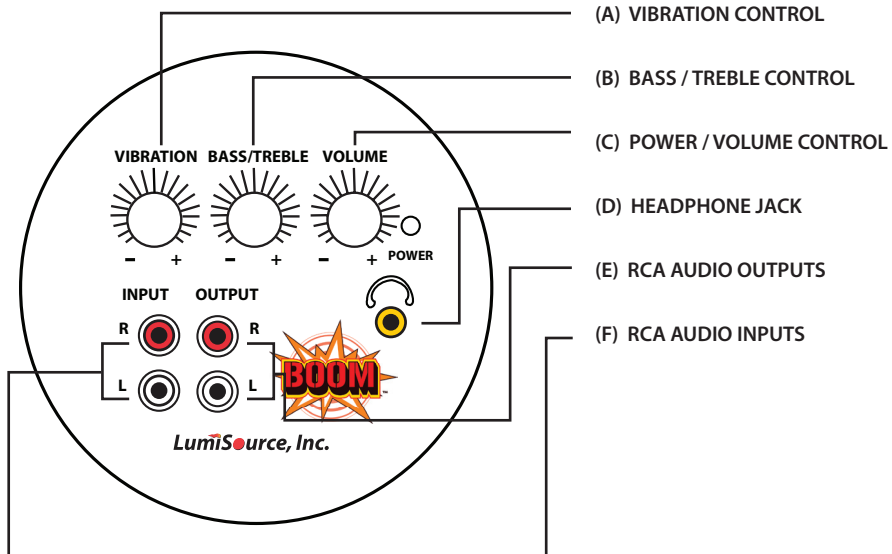

ASSEMBLY INSTRUCTIONS

Step 1: Screw in two support poles into backrest and slide into seat.

Step 2: Connect audio cords from backrest and headrest.

Step 3: Connect plugs from base and backrest.

Step 4: Insert receptacle (4) into adapter (2).

Step 5: Plug adapter (2) into outlet.

Step 6: Turn Power/Volume Control (C) clockwise.

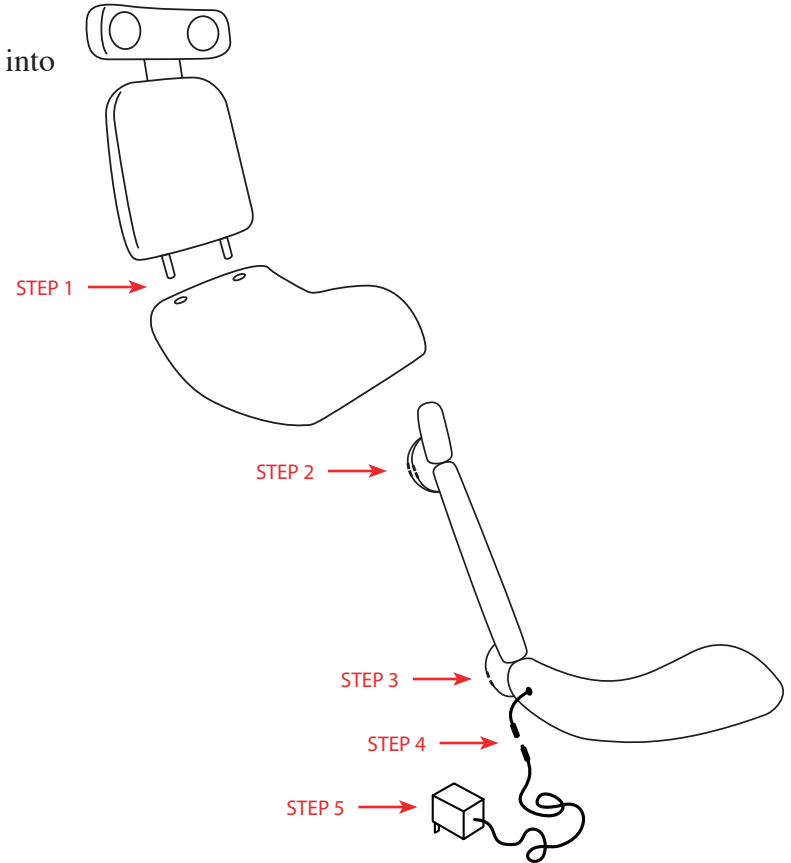

CONNECTING TO GAME CONSOLES

Note: All game consoles are supplied with a custom connector with yellow video out and RCA red/white audio out.

- Step 1: Plug yellow composite video cable from game console into video input of TV. (Fig. 1)
- Step 2: Plug Red/White RCA cord from game console into RCA INPUT (F) of BoomChair™ MIG. (Fig. 2)

*Alternate Connection:
Connect directly from the TV Audio Out to the BoomChair™ Audio Input using the RCA audio cords provided.*

Note: It may be necessary to extend your BoomChair MIG further away from your TV or console. Here's how. (fig.3)

- Step 1: Connect Audio Coupler (3c) to Red/White RCA cord from game console.
- Step 2: Connect one end of RCA cord (3b) into other end of Audio Coupler (3c).
- Step 3: Connect other end of RCA cord (3b) into RCA INPUT (F) of BoomChair™ MIG.

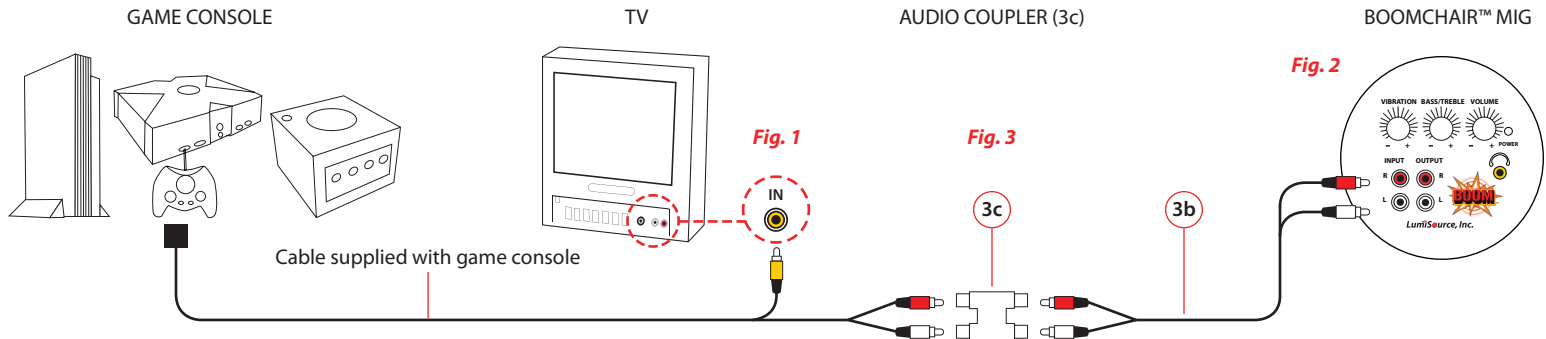

CONNECTING TO HAND-HELD GAMES, MP3 PLAYERS & CD/DVD PLAYERS

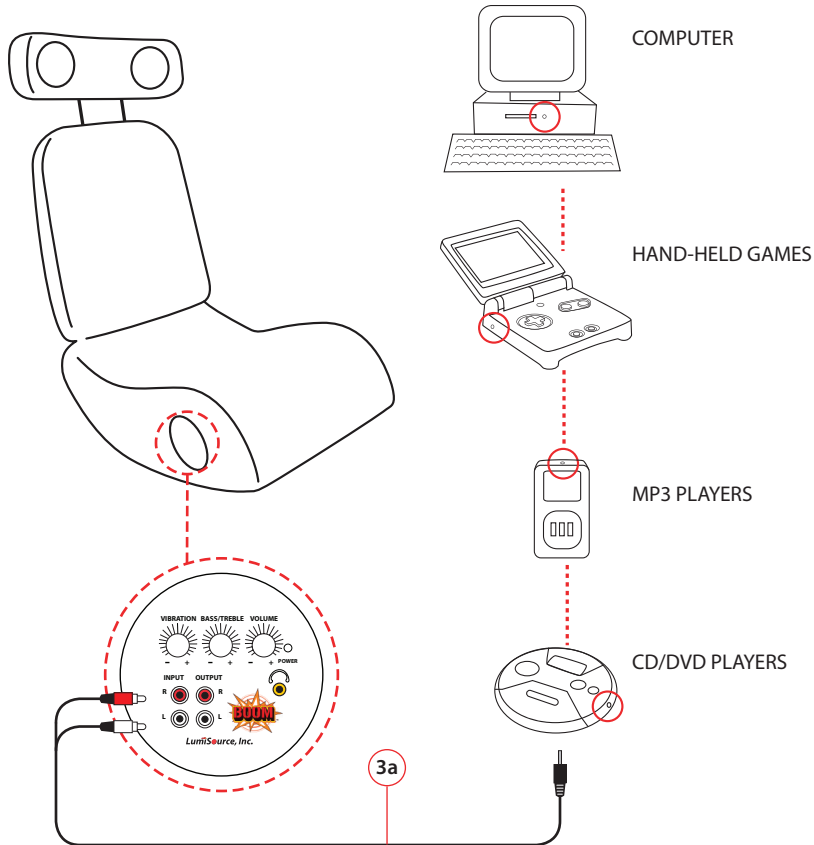

Step 1: Plug the single end of the RCA cord (3a) into the headphone jack of your device.

Step 2: Plug the pair of RCA cords into RCA INPUT (F) on the BoomChair™ MIG.

③a = headphone jack to audio left & right channel connectors.

DAISY CHAINING CHAIRS TOGETHER : UP TO 4 CHAIRS

Step 1: Connect BoomChair™ MIG to any media device as described on pg. 7 or pg. 8. This is the first chair.

Step 2: Connect one end of RCA cord (3b) into RCA OUTPUT (E) of first BoomChair™ MIG.

Step 3: Connect other end of RCA cord (3b) into RCA INPUT (F) of second BoomChair™ MIG.

Repeat steps 2 and 3 from second chair to connect more BoomChair™ MIG's.

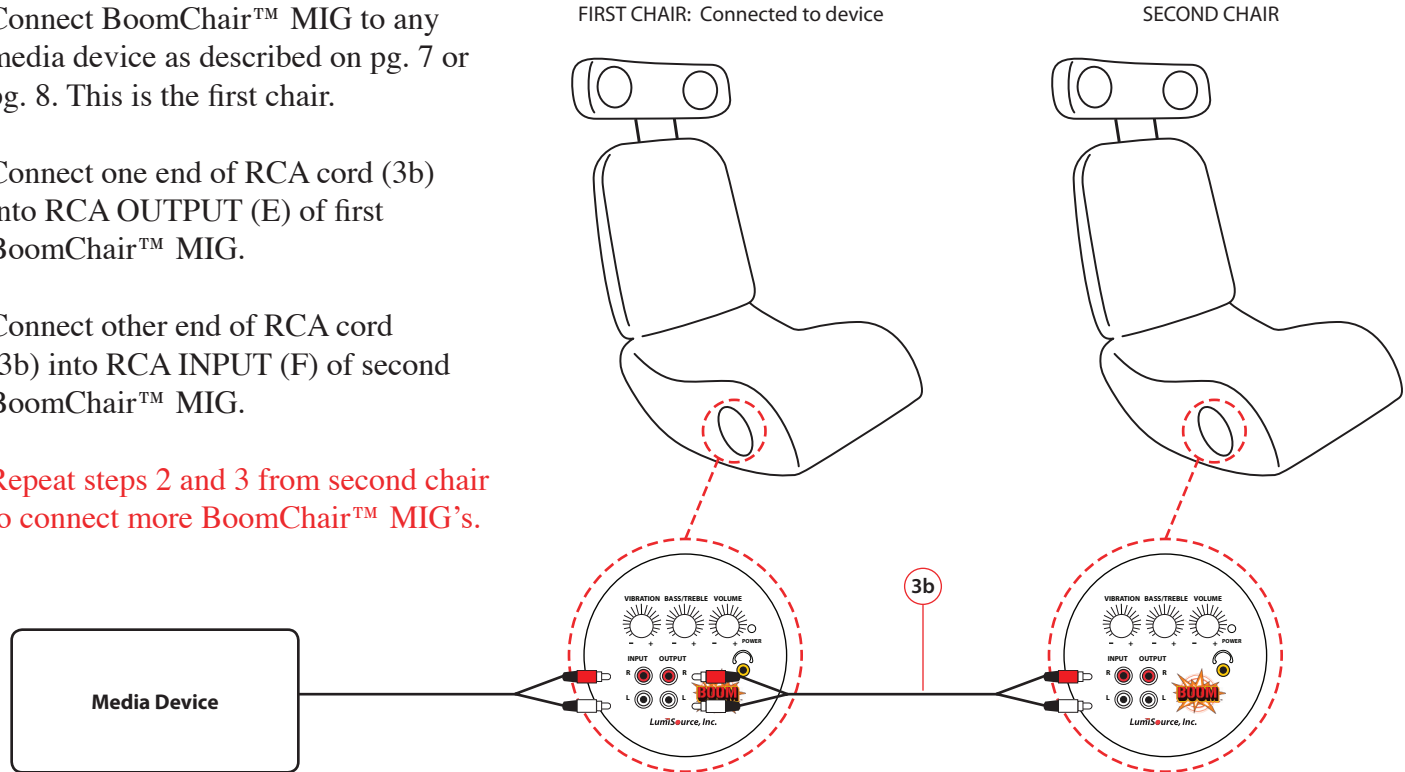

TROUBLESHOOTING BOOMCHAIR™ MIG

Q: Why isn't there sound coming from any of my speakers?

A: Ensure your BoomChair™ MIG is connected as described in the Setup Guide. Check that the power to the unit is on and the volume is turned up. Also, make sure your audio device is not set to "MUTE" and volume is turned up.

Q: Why isn't there sound coming from one of the speakers?

A: Ensure the audio cord to the BoomChair™ MIG is securely connected as described in the Setup Guide.

Make sure that both the left and right channel audio inputs and outputs are securely connected to the BoomChair™ MIG and audio device.

Q: Why don't I feel any vibration?

A: Make sure the vibration control is switched on. The vibration is sensitive to volume and bass because it interacts with the music/game. Adjust the sensitivity of the vibration, volume, and bass according to your desired settings.

Q: Where can I get more information?

A: Visit us at www.BoomChair.com or www.LumiSource.com

Contact information: LumiSource, Inc. 2950 Old Higgins Road, Elk Grove Village, IL 60007

E-mail: customerservice@lumisource.com

MAINTENANCE AND REPAIR

If a problem occurs while using this product, please contact us. DO NOT open unit or attempt to repair on your own. It may result in serious injury from electric shock and void your product warranty.

CLEANING/CARE INSTRUCTIONS

Fabric: Use a clean cloth to dab lightly with soap and water. DO NOT rub.

DO NOT immerse in water. DO NOT use detergent.

NOTE: PLEASE DO NOT USE ON HARDWOOD FLOORS, IT MAY CAUSE SCRATCHING.

LUMISOURCE, INC. LIMITED WARRANTY

LIMITED WARRANTY: LumiSource, Inc. (“LumiSource”) warrants this product against defects in materials and workmanship for a period of ninety (90) days from the date of original consumer purchase. If a covered warranty claim is timely made, LumiSource will, at its sole discretion: (a) repair the product, using new and/or refurbished replacement parts or (b) replace the product with an identical (or comparable) product, without charge to you other than the initial shipping cost to return the product. LumiSource will only pay return shipping charges for destinations within the 48 contiguous U.S.A., if the returned product is covered by the limited warranty.

WHAT THIS WARRANTY DOES NOT COVER: This warranty does not cover defects resulting from accidents, alterations, unauthorized repair, failure to follow instructions, misuse, commercial use, fire, flood, or acts of God.

WHAT WE ASK YOU TO DO: If there is a covered defect, please write or email us within 90 days of the date of purchase at the address noted on page 8 to obtain instructions and authorization to return the product to LumiSource. You will need to pack the product securely in packaging providing at least the degree of protection of the original carton and packing materials and ship it to us at your expense. You will also need to include with the product (a) a copy of your original proof of purchase (retail receipt) showing the date of purchase and (b) a detailed explanation of the problem(s) requiring service.

TO THE EXTENT PERMITTED BY LAW, THIS LIMITED WARRANTY AND THE REMEDIES SET FORTH ABOVE ARE EXCLUSIVE AND IN LIEU OF ALL OTHER WARRANTIES, REMEDIES AND CONDITIONS, ORAL OR WRITTEN, EXPRESS OR IMPLIED. TO THE EXTENT PERMITTED BY LAW, LUMISOURCE HEREBY DISCLAIMS ANY IMPLIED WARRANTIES, INCLUDING WITHOUT LIMITATION, WARRANTIES OF MERCHANTABILITY AND FITNESS FOR A PARTICULAR PURPOSE. TO THE EXTENT APPLICABLE STATE LAW EXCLUDES SUCH DISCLAIMERS, THEN TO THE EXTENT ALLOWED BY LAW, THE TIME FOR ANY CLAIMS FOR SUCH IMPLIED WARRANTIES SHALL EXPIRE 90 DAYS FROM THE DATE OF ORIGINAL CONSUMER PURCHASE. TO THE EXTENT PERMITTED BY LAW, LUMISOURCE IS NOT RESPONSIBLE FOR DIRECT, SPECIAL, INCIDENTAL OR CONSEQUENTIAL DAMAGES, INCLUDING BUT NOT LIMITED TO LOSS OF TIME, INCONVENIENCE, LOSS OF USE OF YOUR PRODUCT, OR PERSONAL INJURY OR PROPERTY DAMAGE, CAUSED BY YOUR PRODUCT OR ITS FAILURE TO WORK.

This limited warranty gives you specific legal rights. Some states do not allow the exclusion or limitation of incidental or consequential damages, and applicable law may not permit the exclusion of certain implied warranties. You may also have their rights, which vary, from state to state.

CHECK OUT OUR OTHER BOOM AFFILIATED PRODUCTS:

BOOMCHAIR™ P42



BOOMCHAIR™ 2.0

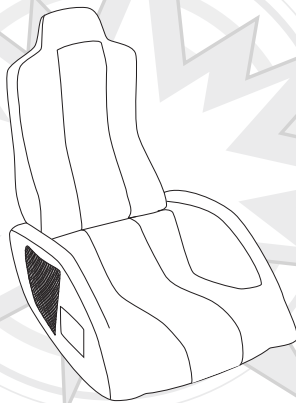

BOOMCHAIR™ P32

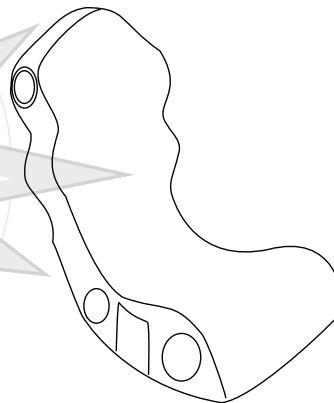

LumiSource®

2950 Old Higgins Road, Elk Grove Village, IL 60007

E-mail: customerservice@lumisource.com

www.BoomChair.com or www.LumiSource.com